

QUICK START GUIDE

INSTALLATION - OPERATION - MAINTENANCE

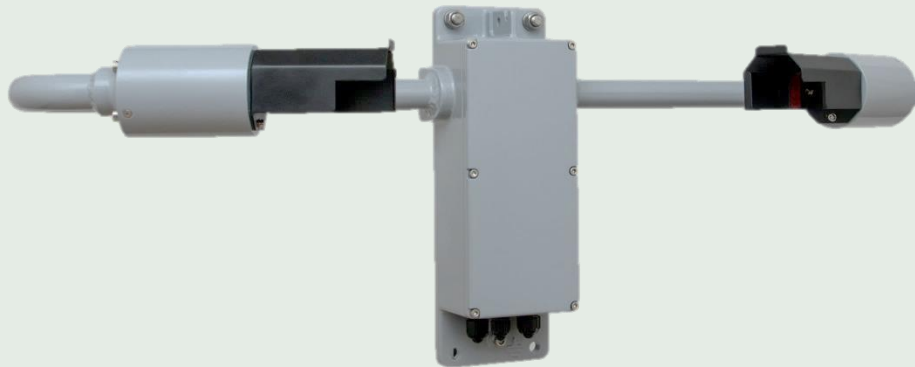

PROPRIETARY NOTICE

The information contained in this manual (including all illustrations, drawings, schematics and parts lists) is proprietary to BIRAL. It is provided for the sole purpose of aiding the buyer or user in operating and maintaining the instrument. This information is not to be used for the manufacture or sale of similar items without written permission.

COPYRIGHT NOTICE

No part of this manual may be reproduced without the express permission of BIRAL.
© 2022 Bristol Industrial and Research Associates Limited (BIRAL)



Biral – P O Box 2, Portishead, Bristol BS20 7JB, UK

Tel: +44 (0)1275 847787

Email: info@biral.com

www.biral.com

Manual Number : 107207

Revision : 00C



RoHS
compliant

Thank you for choosing Biral as your supplier of Road Weather Sensors

This guide is intended to get your RWS-20 sensor installed and working as quickly as possible with the most common (Default) settings, and is intended for people who are familiar with installing electrical equipment.

Further information and configuration details can be found in the User Manual. If you are unfamiliar with this product, please consult both this quick start guide and the user manual before installation.

Please note these units are supplied calibrated, any damage during transit or installation should be reported.

The RWS User Manual is free to download from:

<http://www.biral.com/technical-support/downloads/manual-downloads/>

Contents

| | | |
|----------|--|-----------|
| 1 | IN THE BOX | 4 |
| 2 | SENSOR FEATURES | 5 |
| 3 | SENSOR CONNECTIONS | 6 |
| 3.1 | CONNECTING POWER..... | 6 |
| 3.2 | CONNECTING COMMUNICATIONS..... | 7 |
| 3.3 | CONNECTING ANALOGUE OUTPUTS | 8 |
| 3.4 | CONNECTING THE RELAYS (OPTIONAL) | 8 |
| 3.5 | CONNECTING THE FERRITES..... | 9 |
| 4 | CONFIRMING THE COMMUNICATIONS | 10 |
| 5 | CONFIRMING THE OUTPUTS | 11 |
| 5.1 | ANALOGUE SIGNAL CHECKS | 11 |
| 5.2 | RELAY CHECKS | 11 |
| 6 | SENSOR INSTALLATION | 12 |
| 6.1 | MOUNTING DETAILS | 13 |
| 6.2 | ELECTRICAL GROUNDING / PROTECTION | 14 |
| 7 | MAINTENANCE | 15 |
| 7.1 | CALIBRATION CHECK | 15 |
| 7.2 | WINDOW CLEANING | 15 |

Your safety is important, whilst this sensor has been designed to be safe in operation, it can be made unsafe through incorrect installation practices. Please follow the instructions contained within this guide and the manual; statements marked with a warning triangle are especially important for safety and performance of the unit.











Before you start installation of this unit; be aware of, and follow, all labelling and safety regulations applicable to the location you are installing this sensor.



1 IN THE BOX

The sensor is securely packed in an appropriate shipping container. Should the contents be damaged, please inform Biral at the earliest opportunity.

In the box with your RWS sensor, you will find:

| Part | Qty | Identification | Biral part number |
|---|---------|---|-------------------|
| 'U' mounting bolts | 2 |  | 105252 |
| M8 nuts | 4 |  | 104749 |
| M8 Washers | 4 each | Plain  | Plain 104736 |
| | | Split  | Split 105449 |
| Mounting saddle | 2 |  | 105356 |
| Clip ferrite | 2 |  | 105457 |
| Cable gland sealing plugs (Fitted to sensor) | 2 x M12 | M12  | M12 106185 |
| | 2 x M16 | M16  | M16 106186 |
| Quick start guide (This document) | 1 |  Please also download the User Manual from the Biral website | 107207 |
| Calibration certificate | 1 |  | N/A |
| You may also have Calibration kit* (optional) | 1 |  | 105634 |

*The calibration kit is in a protective carrying case, containing: a calibration plaque, a mounting arm (referred to as the calibration reference plaque when assembled) and 3 grey foam plugs.

2 SENSOR FEATURES

The RWS sensor can be configured to suit different requirements

Standard features

| Configurable option | Default | Additional optional settings |
|----------------------------|----------------|---|
| Visibility | 10m – 7500m | 10m to (600m to 7500m) |
| Serial data output | RS232 | RS422/485 |
| Baud rate | 9600 | configurable between 1200 to 57600 baud |
| 0-10v | EXCO | MOR |

Optional features

| Configurable option | Default | Additional optional settings | |
|----------------------------|-------------------------|--------------------------------------|-----------------|
| 4-20mA | EXCO | MOR | |
| Relays | Fault, RL1-1km, RL2-2km | Fault, RL1-1km, window contamination | Relays Disabled |

This Quick Start Guide assumes the most common (Default) settings are required. Should you require any of the optional settings, the User Manual gives comprehensive details of how to configure and change these settings.

3 SENSOR CONNECTIONS

To access the connection terminals, you will need to open the RWS sensor, by loosening the captive screws on the front panel.

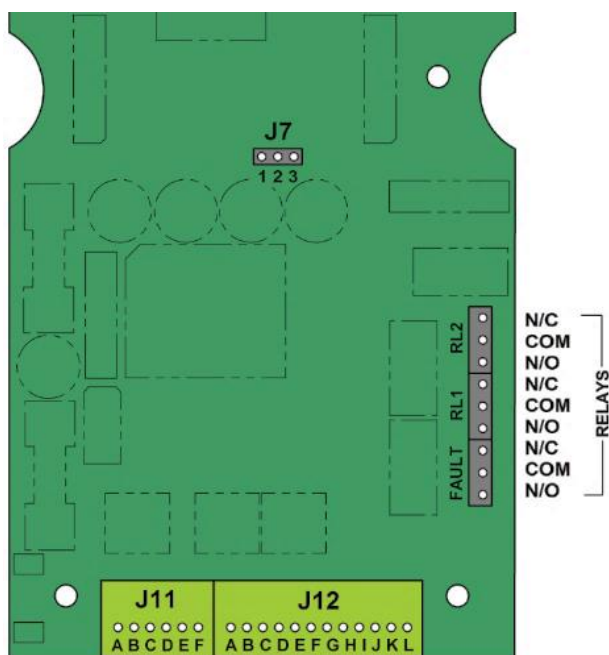

Figure 1: PCB diagram showing J7, J11, J12, and the relay connections

For J11 and J12 Connectors, strip back the wire 11mm. This connecting strip is of a lever clamp design. The wire is released by pressing on the orange lever with a small screwdriver with a flat blade of no more than 2.5mm.

3.1 CONNECTING POWER

| Pin Number | Designation | Wire size | Wire size |
|------------|--------------------------------|-----------|-------------------------|
| J11/A | Hood Heater Supply 24VAC or DC | 20-26AWG | 0.5-0.13mm ² |
| J11/B | Hood Heater Return 24VAC or DC | 20-26AWG | 0.5-0.13mm ² |
| J11/C | Power +9 to +36V DC Supply | 20-26AWG | 0.5-0.13mm ² |
| J11/D | Power 0V Supply | 20-26AWG | 0.5-0.13mm ² |
| J11/E & F | Not Used | 20-26AWG | 0.5-0.13mm ² |

This sensor **MUST BE EARTHED**. Failure to install a suitable earth may result in inaccurate readings and / or damage to the sensor. Failure to install an earth when using mains voltages on the relays will make the unit potentially unsafe.

J11/D is the internal signal ground reference point. Care must be taken, to ensure that this negative supply lead is at or near ground potential. If it develops more than $\pm 10V$ DC with respect to ground, damage will be caused to the sensor.



3.2 CONNECTING COMMUNICATIONS

The RWS-20 can be operated with either RS232 or RS422 or RS485 communications. It is not possible to operate both the RS232 and the RS422/RS485 together. Use Jumper J7 to select desired communications protocol.

| Communication protocol | Jumper position |
|------------------------|-----------------|
| RS422/RS485 | 1&2 |
| RS232 | 2&3 |

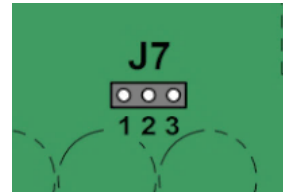

Figure 2: J7 pin numbering

If the board is orientated with J11 and J12 at the bottom, pin 1 of J7 is to the left. J7 is located in the middle of the board next to capacitors (see Figure 1)

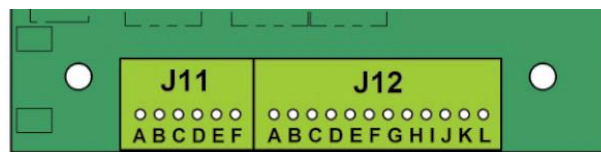

Figure 3: Pin connections for communications

Pin connection for RS232

| Pin Number | Designation | Wire size | |
|------------|--------------------------------|-----------|-------------------------|
| J12/A | RS232 common/0V | 20-26AWG | 0.5-0.13mm ² |
| J12/B | RS232 Tx (signals FROM sensor) | 20-26AWG | 0.5-0.13mm ² |
| J12/C | RS232 Rx (signals TO Sensor) | 20-26AWG | 0.5-0.13mm ² |

Pin connections for RS422/485

| Pin Number | Designation | Wire size | |
|------------|-------------------------------|-----------|-------------------------|
| J12/A | RS422/485 common/0V | 20-26AWG | 0.5-0.13mm ² |
| J12/D | RS422/RS485 Rx+ (TO sensor) | 20-26AWG | 0.5-0.13mm ² |
| J12/E | RS422/RS485 Rx- (TO Sensor) | 20-26AWG | 0.5-0.13mm ² |
| J12/F | RS422/RS485 Tx- (FROM sensor) | 20-26AWG | 0.5-0.13mm ² |
| J12/G | RS422/RS485 Tx+ (FROM Sensor) | 20-26AWG | 0.5-0.13mm ² |

3.3 CONNECTING ANALOGUE OUTPUTS

Pin connections for analogue outputs

| Pin Number | Designation | Wire size | |
|------------|------------------------------|-----------|-------------------------|
| J12/H | 0-10V Analogue Output +ve | 20-26AWG | 0.5-0.13mm ² |
| J12/I | 0-10V Analogue Output -ve | 20-26AWG | 0.5-0.13mm ² |
| J12/J | 4 – 20mA Analogue Output +ve | 20-26AWG | 0.5-0.13mm ² |
| J12/K | 4 – 20mA Analogue Output -ve | 20-26AWG | 0.5-0.13mm ² |
| J12/L | Not Used | 20-26AWG | 0.5-0.13mm ² |

3.4 CONNECTING THE RELAYS (OPTIONAL)

Care must be taken to ensure that the voltage rating of the cable is correct for the switching application requirement. If the relays are to be used with mains voltages, please comply with all national and international safety regulations. A protective earth bonding test of the sensor housing should be carried out.



The relay connectors are a two-part connector with pins in the circuit board and a removable plug for the connections. It is advised that the plug is removed from the pins to enable the connections to be made to the cable before re-connecting to the circuit board. The connections are of a screw clamp type. For the relay connectors strip back wire insulation by 5mm. Relays are rated at 250Volts AC, 2Amps.

Pin connections for Relay connections

| Pin | Designation | Wire size | |
|-------|-----------------|-----------|-------------------------|
| RL2 | Normally Closed | 16-26AWG | 1.3-0.13mm ² |
| RL2 | Common terminal | 16-26AWG | 1.3-0.13mm ² |
| RL2 | Normally Open | 16-26AWG | 1.3-0.13mm ² |
| RL1 | Normally Closed | 16-26AWG | 1.3-0.13mm ² |
| RL1 | Common terminal | 16-26AWG | 1.3-0.13mm ² |
| RL1 | Normally Open | 16-26AWG | 1.3-0.13mm ² |
| Fault | Normally Closed | 16-26AWG | 1.3-0.13mm ² |
| Fault | Common terminal | 16-26AWG | 1.3-0.13mm ² |
| Fault | Normally Open | 16-26AWG | 1.3-0.13mm ² |

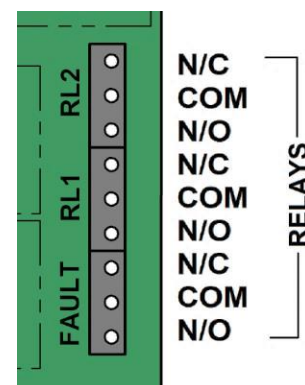

Figure 4: Showing the relay connections

3.5 CONNECTING THE FERRITES

This sensor **MUST HAVE FERRITES INSTALLED**. Failure to install the supplied ferrite cores may result in inaccurate readings or lost communications



The unit is supplied with two clip type ferrites; these are not optional items and must be fitted.

If the ferrites are not fitted, the sensor could be affected by external electromagnetic noise. The ferrites supplied with the unit should be clipped over the power and the signal leads, between the gland and the connector blocks. Ferrites are not required on the relay connections or on the hood heater supplies.

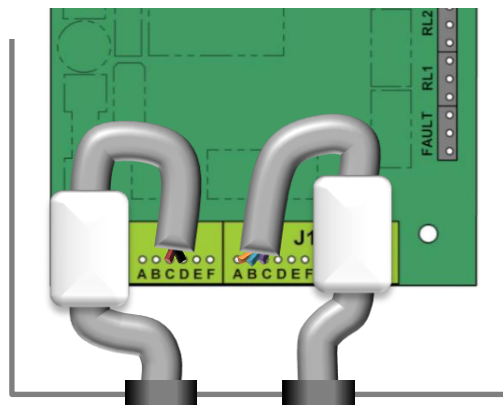

Figure 5: location of the ferrites when installed

4 CONFIRMING THE COMMUNICATIONS

If you are unfamiliar with the sensor, we recommend that the unit is powered and tested prior to mounting, as when mounted the unit could be difficult to access. When checking the functionality use suitable connections, do not short any contacts together.

To confirm the unit functions correctly:

1. Connect your chosen method of communication (RS232, or RS422/485) to a PC running the Biral Sensor Interface Software.
Available to download at:
<http://www.biral.com/technical-support/downloads/software-downloads/>
2. Ensure an earth connection to the chassis, and power connected to J11 C&D (9 to 36V, and 0V)
3. Connect to the Biral Sensor interface software using default 9600 baud
4. Apply power to the sensor: If communications are working the sensor will respond with "Biral Sensor Startup".
5. Check Data Transmission To Sensor:

Send the command `R?` from the PC terminal to the sensor:
The sensor will respond with its Remote Self-Test & Monitoring Message.

For example:

```
100,2.509,24.1,12.3,5.01,12.5,00.00,00.00,100,105,107,00,00,00,+021.0,4063
```

5 CONFIRMING THE OUTPUTS

If you wish to test the outputs of the sensor, use the command 'TEST' to get the unit to temporarily output foggy and clear conditions, which will allow you to check the analogue outputs and (optional) relay thresholds. Use the CO command before the TEST command to access the TEST command.

The command structure is:

TEST,tt,vv,vv,f,c

Where:

| | | |
|-------|-------------------------------|-------------------------------------|
| tt | = Duration of test in minutes | range 00-60 (00 will stop the test) |
| vv.vv | = Visibility will be in km | range 0.01 to 75.00 |
| f | = Fault Indicator | 0=No Fault, 1 = Fault |
| c | = Contamination Indicator | 0=None, 1=Warning, 2=Alert |

Example:

TEST,**02,07.50**,0,0,00 – Outputs a visibility of **7.5** km for **2** min (Clear conditions)

TEST,**06,00.10**,0,0,00 – Outputs a visibility of **0.1** km for **6** min (Foggy conditions)

5.1 ANALOGUE SIGNAL CHECKS

Using a multimeter, set to measure voltage or current as appropriate, measure the connections (J12 H & I (0-10V), or J & K (optional 4-20mA output)) and ensure the output changes when the different conditions are simulated.

Note: The current output should not be terminated with a resistance greater than 500 Ω to enable a maximum of 20mA to be available. The voltage should be read across a resistor greater than 10K Ω .

The RWS analogue outputs can be configured for MOR or EXCO (default) output (See manual for details). Use the following formulas to convert voltage or current readings to MOR or EXCO.

| | 0-10v | 4-20mA (Optional) |
|-------------|------------------------------|-------------------------------------|
| MOR output | $MOR = (Range/10) * V_{out}$ | $MOR = (Range/16) * (mA_{out} - 4)$ |
| EXCO output | $EXCO = (300/10) * V_{out}$ | $EXCO = (300/16) * (mA_{out} - 4)$ |

Range is the maximum configured range of the sensor (EXCO range fixed at 300)

V_{out} = The voltage across the 0-10V output terminals

mA_{out} = The current flowing through the 4-20mA terminals in milliamps

5.2 RELAY CHECKS

Please follow local health and safety procedures if hazardous voltages or currents are present. If in doubt de-energise and disconnect the wires to the relays, and confirm the relays operation through resistance measurement.



Use a multimeter to monitor the relay outputs, whilst simulating high and low visibility. Please note, to prevent repeated switching around the threshold value, the relays have a timer delay and hysteresis built in, the relays can take up to 5 mins to change.

6 SENSOR INSTALLATION

Please consider the following factors when choosing a location for the sensor.

Direct and Reflected Light – Care should be taken to ensure that the sensor is situated with the receiver facing away from any direct sunlight (rising and setting sun) and any surfaces which could cause reflections of the IR (Infrared) illumination from the transmitter (for example walls, bridges, trees and people, etc.). Reflected IR illumination entering the sensor's optics can cause errors in the reported visibility measurements.

Air-flow – Care should be taken to ensure that the sensor is situated away from objects that disrupt the 'normal' flow of air to and through the sensor sampling volume (for example walls, trees and other equipment, etc.).

It is recommended for the RWS sensor:

- To be mounted with the sensor facing away from the traffic, not less than 3 metres away from a road, to avoid spray contaminating the lenses.
- No vegetation (trees, large bushes) within 3 metres in front of the sensor, this is to avoid IR reflections, and no vegetation 1 metre below the sensor.
- The sensor is located at a site where it is safe to install and maintain.

Suggested siting

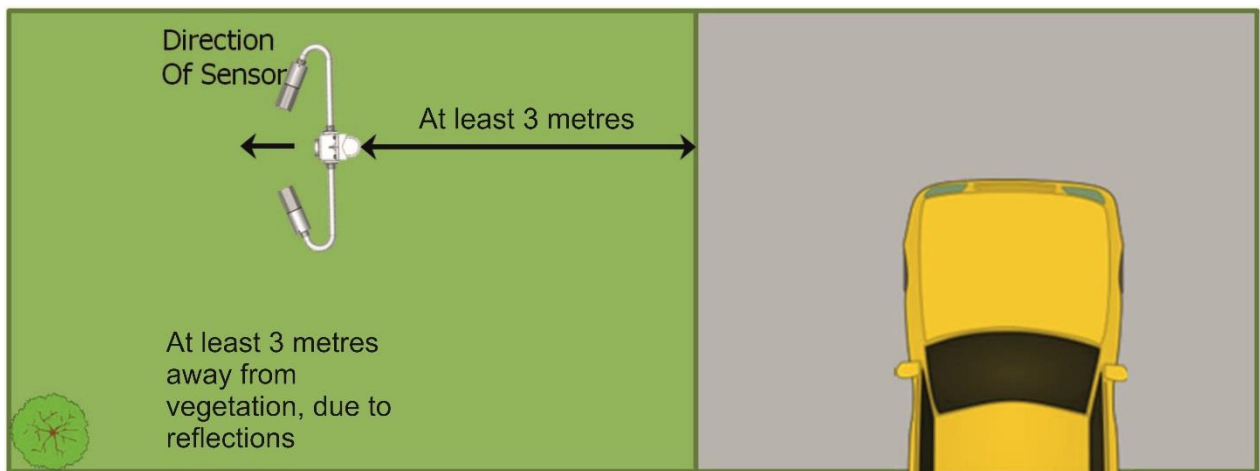

If the above siting is not possible, ensure the Sensor is facing the same direction as the closest traffic.

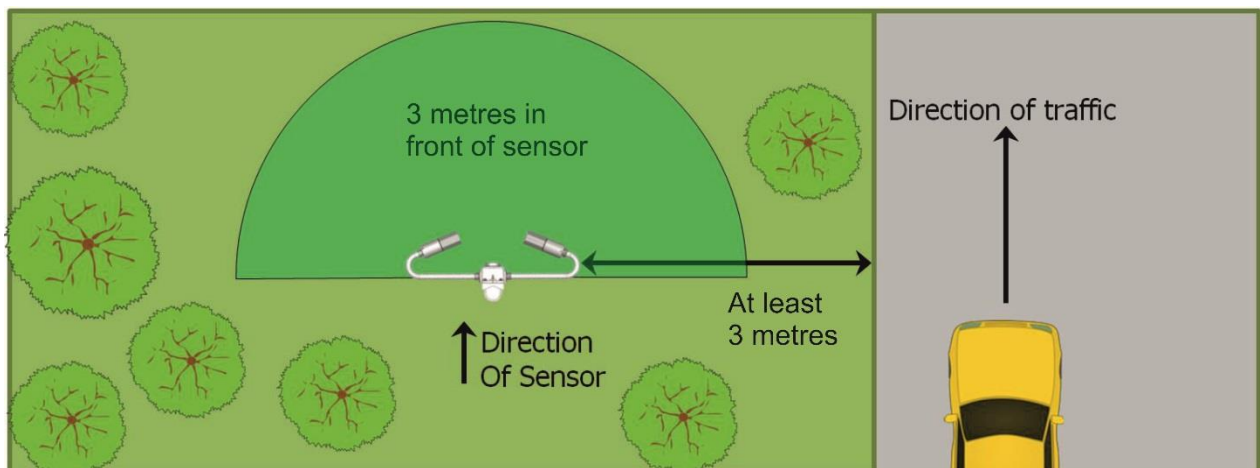

6.1 MOUNTING DETAILS

Any glands not in use should be sealed with the supplied sealing plugs to retain the integrity of the weatherproof housing.

The U bolts fit a standard mounting pole of 40-64mm diameter.

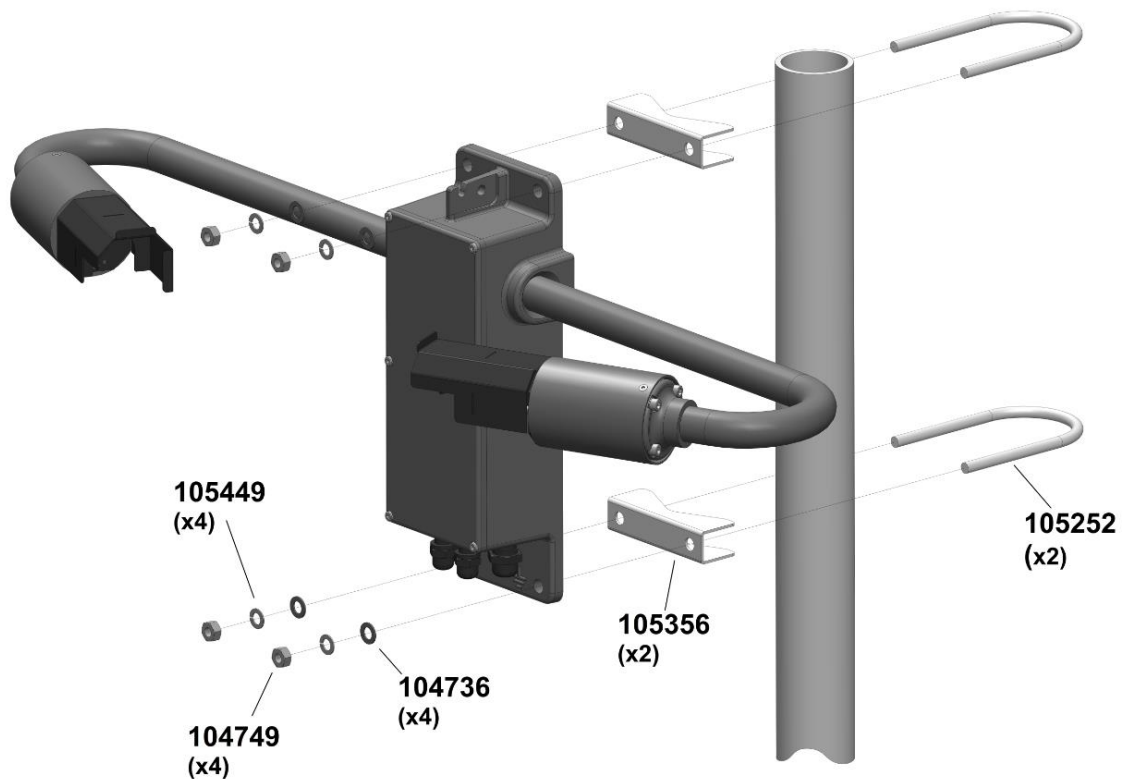

Figure 6: Mounting details

6.2 ELECTRICAL GROUNDING / PROTECTION

This sensor **MUST BE EARTHED**. Failure to install a suitable earth may result in inaccurate readings and / or damage to the sensor. Failure to install an earth when using mains voltages on the relays will make the sensor potentially unsafe.



An M6 earth bolt is provided, this is attached to the earth stud. The Earth Stud is indicated by the Earth symbol embossed in the casing located at the front of the case, between the two front lower bracket mounting holes.

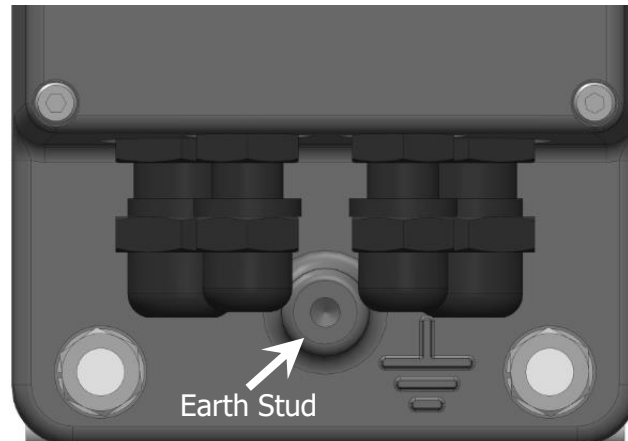

Destructive over volt transients can occur in many ways; e.g., lightning induced transients, AC power line transients and EMI/RFI electromagnetic noise. The power/control subsystem of the sensor contains transient surge-arrestors on all power and signal lines as a standard feature. EMI filters are present on the power and data lines entering the power/control subsystem.

The following notes are intended to provide some guidance in the design and construction of an electrical grounding system.

- (1) Ground Rod: An 2.5m ground rod should be used to make contact with moist soil during even the driest periods.
- (2) 13mm² solid copper wire should be used to connect the instrument (and thus the transient voltage suppressers) to the Ground Rod. Use the shortest and most direct paths to the ground. Simply connect the wire between the Earth Stud provided on the front of the lower mounting flange of the instrument and the Ground Rod
- (3) System Interconnections: Eliminate all isolated ground loops. The shield of the signal output cable, for example, should be attached only at one end of the cable and left floating at the other end. Preferably, it should be attached to ground at the sensor end of the signal cable.
- (4) Connections: Use tight, corrosion-proof bare metal connections throughout the grounding system.

Please ensure that earth safety regulations applicable to your area are followed.

7 MAINTENANCE

The RWS-20 is a calibrated optical instrument and will require maintenance during its lifetime. Please consult the RWS User Manual for more detailed information.

The maintenance periods stated here are recommended maximums only - the period should be determined by the end user.

| Function | Max period between checks |
|-------------------|---|
| Calibration Check | 12 months. (calibration equipment required) |
| Clean Windows | 3 months. (Dependent on local conditions) |

7.1 CALIBRATION CHECK

RWS sensors are electronic instruments and a calibration check should be performed at regular intervals to ensure continued accuracy of the data. Calibration equipment is required for this.

7.2 WINDOW CLEANING

RWS sensors are optical instruments and are therefore susceptible to accumulation of contaminants on the windows in the hoods. The windows should be cleaned by gently wiping the windows using a soft clean cloth and water.

End of Guide

Should you require further information, the RWS user manual is free to download at:
<http://www.biral.com/technical-support/downloads/manual-downloads/>